

T1.61

(mm)

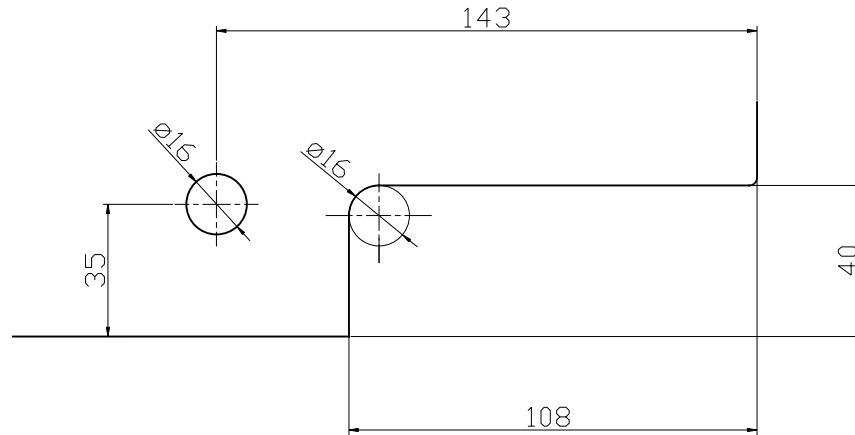

T1.61

(inch)

