

T4.08

(mm)

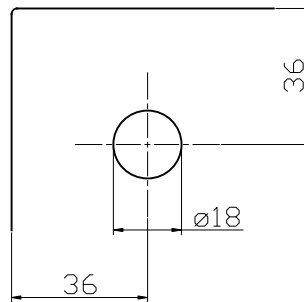

T4.08

(inch)

