

# T4.27

(mm)

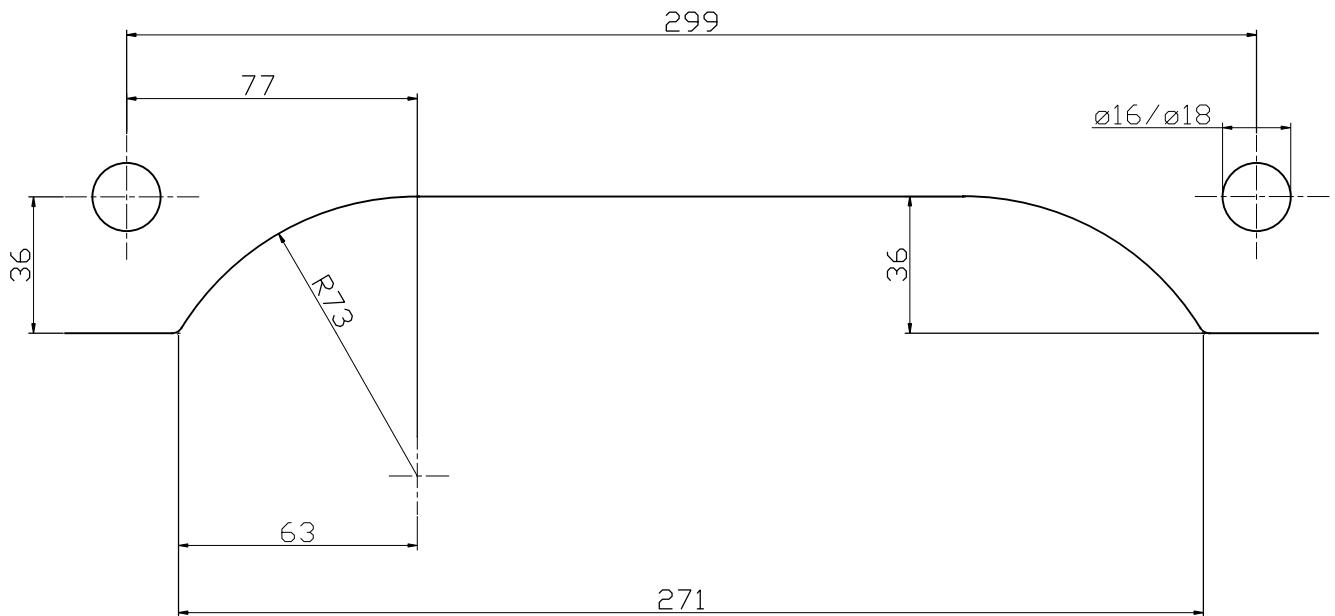

# T4.27

(inch)

